

Installation Instructions

FLEX Ex Power Supply

Catalog Number 1797-PS2E2

Topic	Page
Important User Information	2
About the Power Supply	3
Understand System Planning	4
Installation in Zone 1, 22	6
Electrostatic Charge	8
Outputs	9
Mount the 1797-PS2E2 Power Supply	10
Customer Connections	11
Typical Wiring Configurations	11
Mounting Dimensions and Terminal Base Assignments for the 1797-PS2E2 Power Supply	12
Repair	12
FLEX Ex Power Supply, cat. no. 1797-PS2E2	13
Ferrite Beads	15

Important User Information

Solid state equipment has operational characteristics differing from those of electromechanical equipment. Safety Guidelines for the Application, Installation and Maintenance of Solid State Controls (Publication SGI-1.1 available from your local Rockwell Automation sales office or online at <http://literature.rockwellautomation.com>) describes some important differences between solid state equipment and hard-wired electromechanical devices. Because of this difference, and also because of the wide variety of uses for solid state equipment, all persons responsible for applying this equipment must satisfy themselves that each intended application of this equipment is acceptable.





In no event will Rockwell Automation, Inc. be responsible or liable for indirect or consequential damages resulting from the use or application of this equipment.

The examples and diagrams in this manual are included solely for illustrative purposes. Because of the many variables and requirements associated with any particular installation, Rockwell Automation, Inc. cannot assume responsibility or liability for actual use based on the examples and diagrams.

No patent liability is assumed by Rockwell Automation, Inc. with respect to use of information, circuits, equipment, or software described in this manual.

Reproduction of the contents of this manual, in whole or in part, without written permission of Rockwell Automation, Inc., is prohibited.

Throughout this manual we use notes to make you aware of safety considerations.

WARNING 	Identifies information about practices or circumstances that can cause an explosion in a hazardous environment, which may lead to personal injury or death, property damage, or economic loss.
IMPORTANT	Identifies information that is critical for successful application and understanding of the product.
ATTENTION 	Identifies information about practices or circumstances that can lead to personal injury or death, property damage, or economic loss. Attentions help you identify a hazard, avoid a hazard, and recognize the consequence
SHOCK HAZARD 	Labels may be on or inside the equipment to alert people that dangerous voltage may be present.
BURN HAZARD 	Labels may be on or inside the equipment to alert people that surfaces may be dangerous temperatures.

ATTENTION

This equipment is considered Group 1, Class A industrial equipment according to IEC/CISPR Publication 11. Without appropriate precautions, there may be potential difficulties ensuring electromagnetic compatibility in other environments due to conducted as well as radiated disturbance.

This equipment is supplied as enclosed equipment. It should not require additional system enclosure when used in locations consistent with the enclosure type ratings stated in the Specifications section of this publication. Subsequent sections of this publication may contain additional information regarding specific enclosure type ratings, beyond what this product provides, that are required to comply with certain product safety certifications.

About the Power Supply

1797-PS2E2

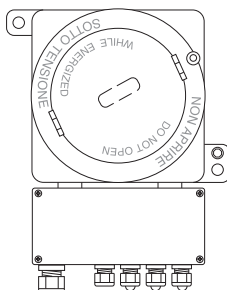

30686

The power supply is an essential component in the operation of an intrinsically safe system. It must isolate the unsafe incoming power from the control system and limit the available energy to IS-safe levels.

No other power sources are needed to operate any components attached to the FLEX Ex system in the hazardous area. Power for valves, actuators, or transmitters come from the FLEX Ex modules.

4 FLEX Ex Power Supply

The 1797-PS2E2 is a 24V dc in/quad-Ex dc out power supply in an flame-proof enclosure with increased safety input and output terminations. The 24V dc gland is an M20 x 1,5 and can accept a cable from 6...12 mm (0.267...0.472 in.) in diameter. The Ex outputs are M16 x 1,5 and can accept a cable from 4...8 mm (0.157...0.315 in.) in diameter.

Features include the following:

- 24V dc supply source
- Four channels, 8.5 W output each channel
- Dual power feeds for source input redundancy
- Outputs are IS galvanically isolated from the source
- All channels are independently IS limited

Understand System Planning

Part of system planning is determining what modules are needed for the application, how many power supplies are needed, how to best partition the system, and where to locate the system cabinets.

A key task in the development cycle is determining the number of power supply outputs (thus power supplies) you will need. In the following example, you will need 11 power outputs if you are using the fiber hub, which requires 8.5 W.

Modules	Requires	Modules	Requires
Fiber hub	8.5 W	Two thermocouple inputs	1.6 W each
Two ControlNet [®] dapters	8.5 W each	Two digital outputs	7.5 W each
Two analog inputs	7.5 W each	Three NAMUR digital inputs	2.8 W each
Two analog outputs	6.3 W each	Two counter inputs	4.25 W each

Each power supply has four independent IS-power outputs capable of 8.5 W each. In the above example, we required 11 IS-power outputs so 3 power supplies were sufficient.

The total number of power supplies needed depends on the modules used and the total system configuration. The following illustration shows how this example may be configured.

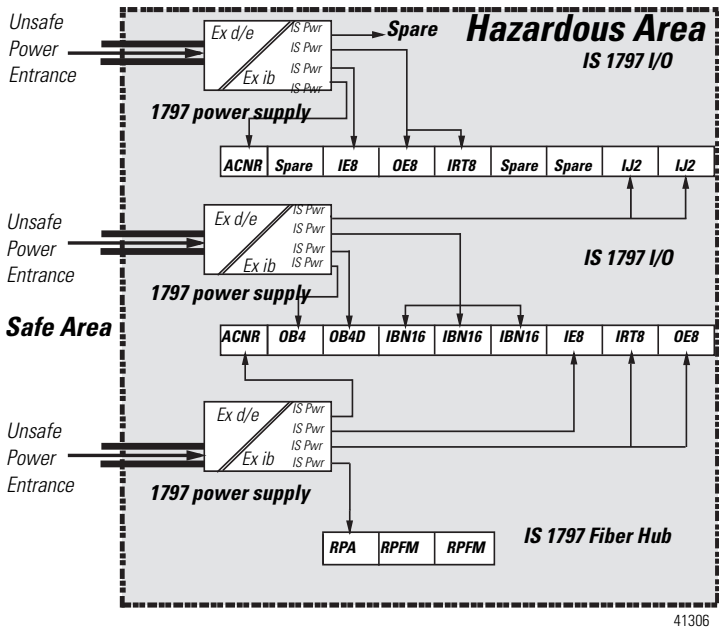

41306

IMPORTANT

Even though modules may be supplied with power from the same power-supply output channel, galvanic isolation in the module provides module-to-module galvanic isolation. Depending upon the module-type, galvanic isolation (channel-to-channel within the module) may or may not be provided. See the module's specifications for more information.

6 FLEX Ex Power Supply

Make certain that you only connect intrinsically-safe power supplies to other intrinsically-safe system modules or adapters to maintain the integrity of the intrinsically-safe backplane.

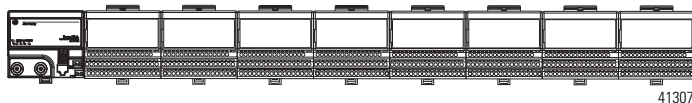

Installation in Zone 1, 22

The 1797-PS2E2 power supply has a protection factor of IP65. Refer to the specifications table for the IS module type.

WARNING

The power supply cannot be used in an intrinsically safe environment after its outputs have been exposed to nonintrinsically safe signals.

Application

When installing, commissioning, operating, and maintaining devices or device components of the FLEX Ex system as intrinsically-safe electrical apparatus in potentially explosive atmospheres according to EN 60079-11, you must heed the EC- type examination certificate and the applicable national and local construction, installation, and operating regulations.

Zone 1

The power supply can be located in Zone 1. The permissible ambient temperature of -20...70 °C must not be exceeded.

Zone 22

The housing type of the power supply is applicable for use in Zone 22. It corresponds with the category 3D acc. to directive 94/9 EC and is marked with a type label accordingly.

Installation and Commissioning

The power supply unit can be located in Zones 1, 2, and 22 as stated on its label. The output circuits are according to the ignition protection class Ex ib and can be installed in Zones 1, 2, and 22. When installing, you must heed the EC- type examination certificate (especially the special conditions) and the applicable national and local construction, installation, and operating regulations.

The housing (Ex d) must not be opened (screw cover). Connections are made in the (Ex e) terminal box.

Install the power feed lines only in the deenergized state. Also follow the information on the type label, respectively the covers of the terminals.

You can connect and disconnect the intrinsically-safe output terminals during operation.

All unused cable glands must be covered by appropriate prototype tested Ex e lead seals to keep the requirement of IP54.

The cover installed on the nonintrinsically-safe screw terminals (IP30) may be removed only in the deenergized state and must be remounted after working on these terminals.

Before closing the cover of the (Ex e) wiring box, inspect the seal for any signs of damage. In case of damage, the seal must be replaced by a new seal that is identical to the damaged seal.

The power supply housing contains two flanges, which can be connected to a wall or other structural part by means of fixing screws. Select fixing screws that ensure secure fixing of the power supply. Consider the condition of vibration of the power supply when making this selection.

On the (Ex d) housing there is an earthing screw. This screw must be connected to Earth with a conductor having a minimum of 4 mm² (0.006 in.²) area. The connection has to be protected against self-opening and corrosion. Corrosion protection can be achieved by using tinned terminal ends.

Before opening the (Ex e) terminal box (for example, for maintenance purposes), it must be cleaned of all dust particles to ensure that no dust can enter the box.

Electrostatic Charge

Protect the system against electrostatic charge. Post a sign near this module.

WARNING Avoid electrostatic charging.

ADVERTÊNCIA! PREVENIR CONTRA O ACÚMULO DE CARGA ELETROSTÁTICA.

For your convenience, a sign that can be cut out and posted is included on the last page of these installation instructions.

European Hazardous Location Approval

The following applies to products marked **CE** **Ex** II 2 G

- Are Equipment Group II, Equipment Category 2, and comply with the Essential Health and Safety Requirements relating to the design and construction of such equipment given in Annex II to Directive 2014/34/EU. See the EC Declaration of Conformity at <http://www.rockwellautomation.com/products/certification> for details.
- The type of protection is “Ex de [ib] IIC T4 Gb” according to EN 60079-11.
- Comply to Standards EN 60079-0:2012, EN 60079-1:2007, EN 60079-7:2007, and EN 60079-11:2012, reference certificate number DMT 02 ATEX E 253 X.
- Are intended for use in areas in which explosive atmospheres caused by gases, vapors, mists, or air are likely to occur occasionally. Such locations correspond to Zone 1 or 2 classification according to ATEX directive 2014/34/EU.

IEC Hazardous Location

The following applies to products with the IECEx certification:

- Are intended for use in areas in which explosive atmospheres caused by gases, vapors, mists, or air are likely to occur only infrequently and for short periods. Such locations correspond to Zone 1 or 2 classification to IEC 60079-0.
- The type of protection is “Ex de [ib] IIC T4 Gb” according to IEC 60079-11.
- Comply to Standards IEC 60079-0:2011, IEC 60079-1:2007-04, IEC 60079-7:2006-07, and IEC 60079-11:2011, reference IECEx certificate number IECEx BVS 09.0019X.

Special Conditions for Safe Use:

For an ambient temperature above 60 °C, power supplies must be connected with leads that are designed for a service temperature of at least 80 °C.

Outputs

When using an intrinsically-safe electrical apparatus according to EN 60079-11, the European directives and regulations must be followed.

The channels in the power supply are electrically connected to each other and have a common +V line.

IMPORTANT

You cannot interconnect lines because of the intrinsic safety requirements.

Mount the 1797-PS2E2 Power Supply

Follow these directions to properly install the 1797-PS2E2 power supply. Refer to the Installation and Commissioning section, page 7, for important precautions and considerations.

ATTENTION



Use star washers and nuts to make sure you have a good electrical connection. Scrape the paint off the back panel in those areas where grounding bolts will be located.

1. Remove the screws on the cover of the power supply Ex e terminal box to access the input and output terminals.
2. Thread the blue IS-safe output power wiring through the blue IS compression seals.
3. Connect the blue IS-safe output power wiring to the output terminals making sure all connections are tight.

These power supply outputs provide the input power to the FLEX Ex modules.

4. Thread the hazardous incoming-power wiring through the black compression seals.
5. Connect the hazardous incoming-power wiring to the input terminals making sure all connections are tight.

You can daisy-chain the hazardous incoming-power wiring to further supplies to simplify system wiring.

ATTENTION



Keep hazardous and IS-safe wiring separated in a suitable fashion. Do not leave long, excess wiring that could bridge between the hazardous and safe areas.

6. Replace the lid of the Ex e terminal box.
7. Screw the lid back into place making sure all of the screws are tight.

Customer Connections

Type of Power Input

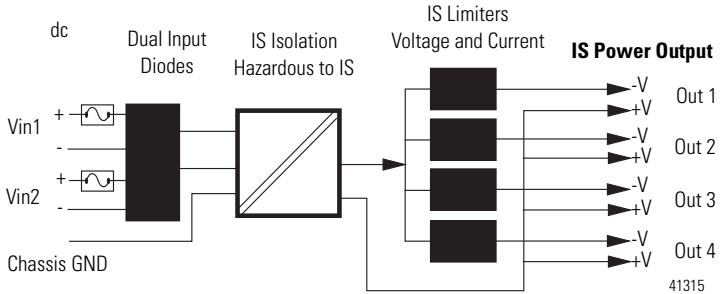

Typical Wiring Configurations

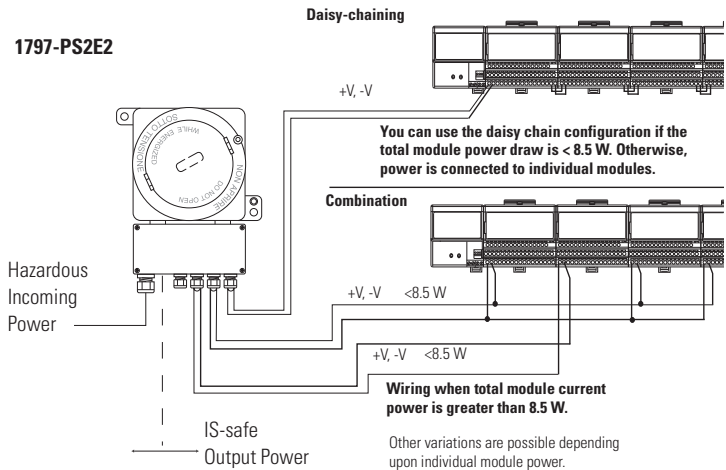

41316

Mounting Dimensions and Terminal Base Assignments for the 1797-PS2E2 Power Supply

Mounting Dimensions

mm (in.)

Height
140 (5.51)

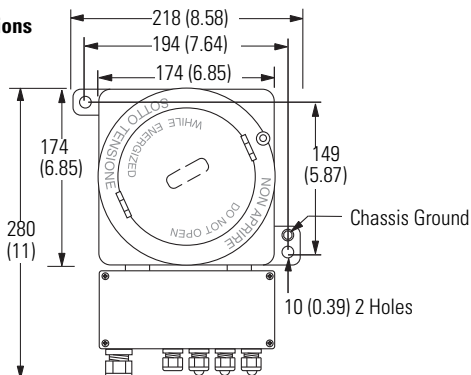

41298A

Terminal Base Assignments

European DC Power Input



+ - + -
Vin1 Vin2



Chassis GND

IS Power Output



+V -V +V -V +V -V +V -V
Out 1 Out 2 Out 3 Out 4

42489

Repair

The power supply is not field-repairable. Any attempt to open this module will void the warranty and IS certification. If repair is necessary, return this module to the factory.

Specifications

Table 1 FLEX Ex Power Supply, cat. no. 1797-PS2E2

Attribute	Value
Input connectors	24V dc Terminals 1, 2, 4, 5
Voltage range	18...32V
Input frequency	N/A
Current consumption	3.1...1.6 A
Ripple	5% ac
Input power entrance	Increased safety
Output connectors	Terminals 10...17
Output power	4 x 8.5 W
Inset voltage range	18...32V dc
Voltage U_0	$\leq 9.5V$
Current I_0	$\leq 1 A$
C_0 (IIC)	$\leq 500 nF$
L_0 (IIC)	$\leq 8 \mu H$
Max output cable resistance (both directions)	$\leq 0.1 \Omega$
Isolation path	
Input power to output power	Galvanic to DIN EN 60079-11
Output to output	None
Input power	55 W
Power dissipation	21 W
Thermal dissipation	71.67 BTU/hr
Conductors wire size	4 mm ² (12 gauge) max wire rated at 100 °C (212 °F) or higher 1.2 mm (3/64 in.) insulation max
Dimensions (HxWxD) approx.	140 mm x 174 mm x 280 mm (5.51 in. x 6.9 in. x 11.0 in.)
Protections class	IP 65/NEMA 7B
Weight (approx.)	7.7 kg (17 lb)

Table 2 Environmental Specifications

Attribute	Value
Operating temperature	IEC 60068-2-1 (Test Ad, Operating Cold), IEC 60068-2-2 (Test Bd, Operating Dry Heat), IEC 60068-2-14 (Test Nb, Operating Thermal Shock): -20...70 °C (-4...158 °F)
Storage temperature	IEC 60068-2-1 (Test Ab, Unpackaged Nonoperating Cold), IEC 60068-2-2 (Test Bb, Unpackaged Nonoperating Dry Heat), -40...85 °C (-40...185 °F)
Relative humidity	IEC 60068-2-30 (Test Db, Unpackaged Nonoperating Damp Heat): 5...95% noncondensing
Shock Operating Nonoperating	IEC60068-2-27 (Test Ea, Unpackaged shock): 15 g 15 g
Vibration	IEC60068-2-6 (Test Fc, Operating): 2 g @ 10...500 Hz
Emissions	CISPR 11 Radiated, Class A Conducted, Class B

Table 3 Certifications

Certifications (when product is marked) ⁽¹⁾	Value
C-Tick	Australian Radiocommunications Act, compliant with: AS/NZS CISPR11; Industrial Emissions
INMETRO	BR-Ex de [ib] IIC T4 Certificate number 05/UL-BRAE-0018X
IECEX	Ex de[ib] IIC T4 Gb Cert no. IECEX BVS 09.0019X

⁽¹⁾ See the Product Certification link at www.ab.com for Declarations of Conformity, Certificates, and other certification details.

Ferrite Beads

Pass all IS power-supply output wires through the ferrite bead before connecting the cable to the power supply.

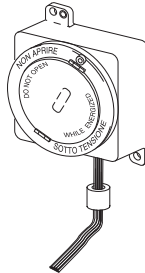

30889

WARNING Avoid electrostatic charging.
**ADVERTÊNCIA! PREVENIR CONTRA O ACÚMULO
DE CARGA ELETROSTÁTICA.**

Rockwell Automation Support

Rockwell Automation provides technical information on the Web to assist you in using its products. At <http://support.rockwellautomation.com>, you can find technical manuals, a knowledge base of FAQs, technical and application notes, sample code and links to software service packs, and a MySupport feature that you can customize to make the best use of these tools.

For an additional level of technical phone support for installation, configuration, and troubleshooting, we offer TechConnect Support programs. For more information, contact your local distributor or Rockwell Automation representative, or visit <http://support.rockwellautomation.com>.

Installation Assistance

If you experience a problem with a hardware module within the first 24 hours of installation, please review the information that's contained in this manual. You can also contact a special Customer Support number for initial help in getting your module up and running.

United States	1.440.646.3434 Monday – Friday, 8am – 5pm EST
Outside United States	Please contact your local Rockwell Automation representative for any technical support issues.

New Product Satisfaction Return

Rockwell tests all of its products to ensure that they are fully operational when shipped from the manufacturing facility. However, if your product is not functioning, it may need to be returned.

United States	Contact your distributor. You must provide a Customer Support case number (see phone number above to obtain one) to your distributor in order to complete the return process.
Outside United States	Please contact your local Rockwell Automation representative for return procedure.

Allen-Bradley, Rockwell Automation, ControlLogix, RSLogix, TechConnect, and FLEX I/O are trademarks of Rockwell Automation, Inc.

Trademarks not belonging to Rockwell Automation are property of their respective companies.

Rockwell Automation maintains current product environmental information on its website at

<http://www.rockwellautomation.com/rockwellautomation/about-us/sustainability-ethics/product-environmental-compliance-page>.

www.rockwellautomation.com

Power, Control and Information Solutions Headquarters

Americas: Rockwell Automation, 1201 South Second Street, Milwaukee, WI 53204-2496 USA, Tel: (1) 414.382.2000, Fax: (1) 414.382.4444

Europe/Middle East/Africa: Rockwell Automation, Vorstlaan/Boulevard du Souverain 36, 1170 Brussels, Belgium, Tel: (32) 2 663 0600, Fax: (32) 2 663 0640

Asia Pacific: Rockwell Automation, Level 14, Core F, Cyberport 3, 100 Cyberport Road, Hong Kong, Tel: (852) 2887 4788, Fax: (852) 2508 1846

Publication 1797-IN535F-EN-P - August 2017

PN-455786

Supersedes Publication 1797-5.8 - June 2010

Copyright © 2017 Rockwell Automation, Inc. All rights reserved. Printed in the U.S.A.